

DURAN® INNOVATIVE BOTTLE SYSTEMS

BIOPROCESSING
CELL CULTURE
LIFE SCIENCES



DURAN
WHEATON
KIMBLE

Excellence in your hands

 **fisher scientific**
part of Thermo Fisher Scientific

DURAN® YOUTILITY DESIGNED FOR YOU

The Award-Winning Laboratory Bottle System From Duran®



GOOD DESIGN AWARD Japan 2014



WELCOME TO DWK LIFE SCIENCES

A Solution Partner For You

DWK Life Sciences (DWK) is the new name for precision labware. Our company combines the strength of three global leading brands DURAN®, WHEATON® and KIMBLE® with a single aim: to help you achieve **excellence** in your field.

We provide the world's laboratories with the most comprehensive range of labware for scientific research and analytical applications as well as solutions for storage and packaging. We meet our customers' highest expectations as a result of our relentless attention to deliver outstanding value while maintaining a premium quality experience. Our deep understanding of science, markets and applications results in our ability to offer innovative products and services designed to meet our customers' most demanding requirements. Our expertise is based on over 125+ years of market leadership, during which we have won the trust of our customers and distribution partners worldwide. With specialized strength in manufacturing and supply chain excellence, we ensure that you receive the right product at the right time, while meeting premium quality standards.



CONTENTS

DURAN® PURE.....	4-7	Screw Caps, GL 14-GL 45.....	16-19
DURAN® TILT Bottles & Accessories.....	8-11	DURAN® GLS 80® Baffled Bottles	20
DURAN® YOUTILITY Bottles & Accessories	12-13	DURAN® GLS 80® Double Wall Bottles	21-22
DURAN® PressurePLUS Bottles	14-15	Screw Caps GLS 80®	23-24
DURAN® HPLC Bottle.....	15	Ordering Information	25
DURAN® Aspirator Bottles	16	Technical Information.....	26-27

DURAN® PURE

INTERMEDIATE BIOLOGIC BOTTLE SYSTEM WITH COMPREHENSIVE QUALIFICATION PACKAGE



DURAN® PURE

From R&D through Phase III trials, the task of selecting and validating biologic intermediate packaging is a complex matrix of requirements. The inherent properties of DURAN PURE 3.3 borosilicate glass bottles and fluoropolymer screw caps can fulfill your requirement matrix.

DURAN PURE delivers raw material purity with the following features:

- Chemically inert
- Wide usage temperature range
- Excellent gas barrier
- Low leachable/extractable profile
- Biocompatibility

DURAN PURE offers a complete, USP compliant range of bottles from 25mL to 20L. These validation ready sizes are scalable from pilot to production volumes, with the added durability to go from hot "sterile" fills to cold storage.

The DURAN PURE bottle and closure provide moisture permeation rates that support bottle-closure integrity for process biologics; it's the protective environment for long-term stability assurance. DURAN PURE Process Bottle System is supported by a comprehensive, easy to access online validation document package and support services.

DURAN PURE Features	Benefits
Comprehensive validation package <ul style="list-style-type: none"> • Certificate of Analysis (CoA) • Type III Drug Master File (DMF) • Qualification documentation 	DURAN PURE meets the official requirements for documented proof of suitability and traceability of primary packaging material
100% traceability of components <ul style="list-style-type: none"> • Bottle • Screw cap • Cap sealing liner 	DURAN PURE meets the documentation and production requirements of national and international pharmacopeias for primary packaging materials
Supply from a single production lot	Simplifies traceability
100% visual control of the DURAN PURE Bottles and Premium Screw Caps	All the supplied packaging material meets the specified quality standard, reducing the risk of rejection
cGMP change control management	By mutual agreement, planned product related changes will be communicated



DURAN® PURE GLASS BOTTLES & SCREW CAPS

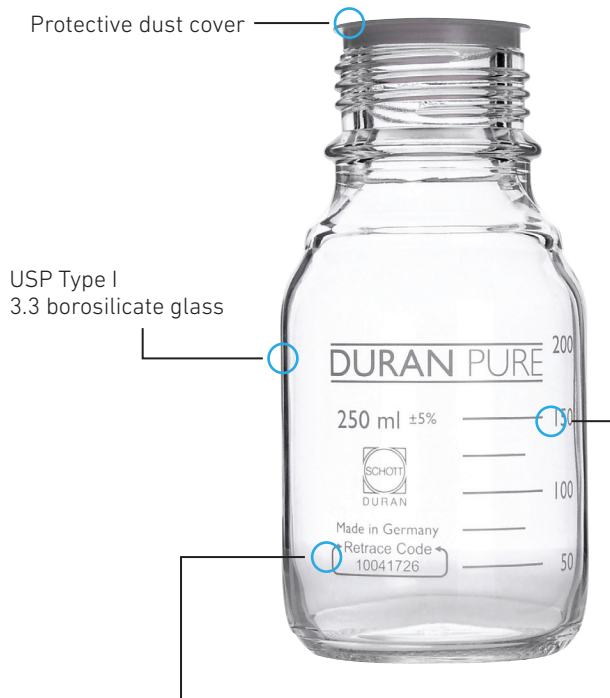

Volume graduations with improved accuracy compared to standard bottles

DURAN® PURE Glass Bottles (Caps are sold separately)

- Conforms to USP <660>, Ph. Eur. 3.2.1 and JP 7.01 Method 1
- Glass type I is a neutral glass and practically inert
- Dust cover conforms to DIN ISO 3585

Cat. No. Clear Glass	Cat. No. Amber Glass	Volume (mL)	DIN Thread	Bottles per case	Bottles per pallet
13-710-912	02-913-014	25	GL25	10	940
13-710-913	02-913-015	100	GL45	10	540
13-710-914	02-913-016	250	GL45	10	280
13-710-915	02-913-017	500	GL45	10	360
13-710-916	02-913-018	1 000	GL45	10	210
13-710-917	02-913-019	2 000	GL45	10	120
13-710-918	02-913-020	5 000	GL45	1	48
13-710-919	02-913-021	10 000	GL45	1	30
13-710-920	02-913-022	20 000	GL45	1	12

DURAN® PURE GLS80 Wide Mouth Glass Bottles (Caps are sold separately)

Cat. No. Clear Glass	Cat. No. Amber Glass	Volume (mL)	DIN Thread	Bottles per case	Bottles per pallet
02-913-023	02-913-026	500	GLS80	10	280
02-913-024	02-913-027	1 000	GLS80	10	210
02-913-025	02-913-028	2 000	GLS80	10	120



DURAN® PURE GLS80 Screw Caps, PSU/PTFE

Cat. No.	DIN Thread	Description	Caps/CS
02-913-031	GLS80	DURAN PURE Premium Screw Cap	5

DURAN® PURE Premium Screw Caps, PFA

- Conforms to USP Class VI <87>, <88> and ISO 10993-5
- No added colorants
- Outstanding temperature resistance from -196°C to 260°C
- PTFE-coated silicone seal is catalytically cured and conforms with FDA
 - FDA 21 CFR §177.1550 for PTFE
 - FDA 21 CFR §177.2600 for elastomers

Cat. No.	DIN Thread	Description	Caps/CS
13-710-921	GL25	DURAN PURE Premium Screw Cap	5
13-710-922	GL45	DURAN PURE Premium Screw Cap	5
02-913-032	GL45	DURAN PURE Premium Lip Seal Cap	5

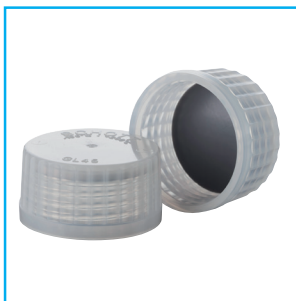

DURAN® PURE — QUALIFICATION DOCUMENTATION AVAILABLE ONLINE

DURAN PURE bottles and closures meet the requirements of the national and international pharmacopoeias, and are supported by a full range of documents and certifications that meet the detailed requirements of the regulatory authorities. A comprehensive qualification package providing product information and supplier qualification is available for download from www.duran-group.com.

Qualification and Validation includes:

	DURAN PURE Bottle/Premium Screw Cap
Certificate of conformity DURAN®	✓
Certificate of conformity USP Class VI	✓
Product specification	✓
Technical drawing	✓
Material Safety Data Sheet (MSDS)	✓
REACH compliance certificate	✓
Certificate of food contact safety	✓
BSE/TSE/GMO certification	✓
Certificate of heavy metal content	✓
Lot certificate	✓
Certificate of Analysis (CoA)	✓
Qualification documentation	✓
Auditing capability	✓
Supplier questionnaire	✓
Drug Master File (DMF), Type III	✓



DURAN® *TILT* MEDIA BOTTLE SYSTEM

Biosafety cabinets and clean hoods are essential for working with cell cultures under sterile conditions. Unfortunately, they make the handling of media bottles difficult and time-consuming for researchers. The DURAN® *TILT* bottle changes everything. The *TILT* bottle has two positions: upright for filter sterilization or storage, and tilted at 45° for pipetting. Take a look at cell culture media from a new angle and discover a bottle system that eases handling and turns usability into security.

GL 56 mouth and screw cap for safer handling

The wide mouth ensures safe and easy pipetting. The ergonomic cap is easy to open and close. Made from non-cytotoxic materials.

100 % bigger opening for easy pipetting

The GL 56 mouth is 100 % larger than the GL 45. It accommodates even large volume pipettes (100 ml) and helps avoid contamination.

Low bottle height for easy handling in safety cabinets

The compact bottle is easy to put through the gap under the sash, and is easier to use inside the hood.

Space saving shape for fridge storage and water baths

The stable and space-saving 500 ml bottle is perfect for fridge storage, or for warming media in a water bath.

Tilted volume indicators for convenience

The clear markings show the volume in both tilted and upright positions and are visible from both sides, for the convenience of left and right-handed users.



Borosilicate 3.3 glass for reusability and lower whole life costs

DURAN® borosilicate 3.3 glass is a tried and trusted material certified as non-cytotoxic (according to ISO 10993-5:2009). DURAN® glass does not leach any organic molecules that might affect the culturing of cells. In addition, DURAN® glass may be depyrogenated to destroy endotoxins using dry heat or chemical based methods.

Vacuum resistant bottle for safe filter sterilization

The bottle is vacuum resistant and may be safely used for the filter sterilization of media.

45° tilt position for pipetting without holding the bottle

Tilt the bottle to its 45° position for pipetting instead of holding it in your hand.

OPTIMIZE YOUR WORKFLOW BY *TILTING*

0°



FILTERING

In the upright position, the DURAN® *TILT* bottle system is ideal for filter sterilizing or clarifying cell culture media. Low bottle height is practical in the biosafety cabinet. DURAN® GL 45 thread adaptor allows any 45 mm filter units to be used with DURAN® *TILT* bottle.

45°



PIPETTING

In the 45° tilted position, the DURAN® *TILT* bottle makes pipetting of media easier under the hood. The innovative design enables both good aseptic and ergonomic practice.



DURAN® bottle top vacuum filtration units

Designed for sterilization or clarification of aqueous cell culture media. Supplied as a filter funnel only unit for use with the DURAN® *TILT* bottle (with GL 45 thread adaptor) or 45 mm media bottles. Comes in three different asymmetric pore sizes (0.1 µm, 0.2 µm, or 0.45 µm). Raised moulded graduation marks for easy volume reading. Manufactured in a Class 100,000 clean room from Class VI, non-cytotoxic materials. Supplied sterile.

As awarded by The Chicago Athenaeum:
Museum of Architecture and Design

GOOD
DESIGN



DURAN® GL 45 thread adaptor (Re-usable)

The re-usable adaptor (GL 45 external / GL 56 internal) allows the use of the DURAN® *TILT* bottle with 45 mm filtration units for the filter sterilization of cell culture media. Manufactured from inert PTFE; can be autoclaved and depyrogenised at 300 °C.

DURAN® *TILT* ACCESSORIES



DURAN® *TILT* GL 56 cap labels

Careful labelling is very important to prevent mix-ups and mistakes. The GL 56 self-adhesive cap labels can be used to clearly indicate the separate bottles of media for each cell line, preventing possible cross-contamination.



DURAN® GL 56 Bottle Tags

The Bottle Tags can be used on their own for colour identification or to secure the protective Light Shield around the bottle. The GL 56 Bottle Tags are available in four colours (orange, yellow, blue and purple).



DURAN® *TILT* protective Light Shield

The DURAN® *TILT* Light Shield is a white silicone sleeve that covers 94% of the bottle surface. The sleeve has a number of protective functions: it blocks damaging ultraviolet (UV) light, protects the glass surface from damage, and facilitates safer handling. Silicone provides a much better grip than glass; especially when the bottle has been sprayed with 70% alcohol for surface disinfection.



Cat. No.	Capacity ml	Thread GL	d mm	h mm	Pack / Quantity
14-209-151	500	56	55	151	4

DURAN® TILT MEDIA BOTTLE SYSTEM GL 56

¹ For chemical and thermal resistance, see page 27.



DURAN® TILT — ACCESSORIES AND REPLACEMENT PARTS

Cat. No.	Description	Material / Color	Pack / Quantity
14-209-152	DURAN® TILT Light Shield includes four GL 56 Bottle Tags (Orange, Yellow, Blue & Purple)	Silicone / White	4
14-209-153	DURAN® GL 56 Bottle Tag Orange	Silicone / Orange	20
14-209-154	DURAN® GL 56 Bottle Tag Yellow	Silicone / Yellow	20
14-209-155	DURAN® GL 56 Bottle Tag Blue	Silicone / Blue	20
14-209-156	DURAN® GL 56 Bottle Tag Purple	Silicone / Purple	20
14-209-157	DURAN® GL 45 thread adaptor for bottle top vacuum filtration unit (GL 45 external, GL 56 internal)	PTFE / White	1
14-209-158	DURAN® TILT GL 56 self-adhesive identification label for screw cap, 40 mm diameter	Polyester / White	60
14-209-159	DURAN® TILT GL 56 screw cap	Polypropylene / White	10



DURAN® BOTTLE TOP VACUUM FILTRATION UNITS

Cat. No.	Description	Membrane pore size (PES)	Pack / Quantity
14-209-160	DURAN® 500 ml Funnel Only 45 mm thread, Gamma sterilized 90 mm Filter diameter	0.1 µm	12
14-209-161		0.2 µm	12
14-209-162		0.45 µm	12

>> GL 45 thread adapter sold separately



DURAN® YOUTILITY BOTTLE SYSTEM

DWK Life Sciences introduces the new bottle system for the 21st century laboratory. The new YOUTILITY bottle system was developed by the DURAN Group, who originated the screw threaded GL 45 DURAN® borosilicate glass laboratory bottle in 1972. Since then the DURAN® GL 45 Laboratory Bottle has become the bottle of choice for laboratories around the world.

Now, the DURAN® YOUTILITY bottle represents a new generation of glass laboratory bottles for use in a wide and diverse range of applications. The innovation does not stop at the improved ergonomic bottle shape, but extends to dedicated accessories that incorporate many new innovative features to improve handling, sample identification, and ease of use. The new YOUTILITY bottles and accessories help to make laboratory work easier, safer, more economical and fun.



GOOD DESIGN AWARD Japan 2014

The specially shaped gripping zones on both sides of the bottle enable easier and safer handling. With the new YOUTILITY bottle thread opening or closing the bottle is significantly faster. The thread is fully compatible with DIN GL 45 closures and other accessories. The slimmer YOUTILITY bottle shape allows a more optimal use of limited space in autoclaves and laboratory refrigerators. A pre-defined labelling area is compatible with the dedicated DURAN® self-adhesive YOUTILITY bottle labels. Nominal volume is shown at the top of the easy-to-read graduation scale for fast determination of the volumes. The glass bottle body is moulded from the tried and tested DURAN® borosilicate 3.3 pharmacopoeial Type 1 neutral glass. DURAN® glass offers very good chemical resistance and high temperature resistance. Each DURAN® YOUTILITY bottle is supplied as a complete system, with a pouring ring (PP¹) and a GL 45 cap (PP¹).

DURAN® YOUTILITY LABORATORY BOTTLE GL 45

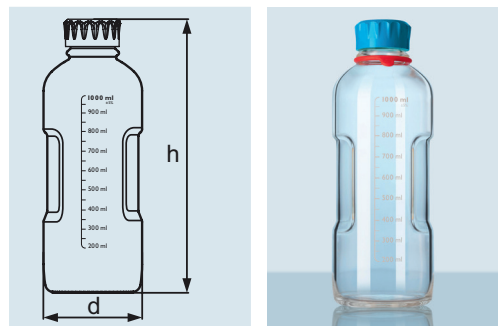

Cat. No. Clear glass	Cat. No. Amber glass	Capacity ml	Thread GL	d mm	h mm	Pack / Quantity
09-841-065	02-900-100	125	45	55	124	4
09-841-066	02-900-101	250	45	66	158	4
09-841-067	02-900-102	500	45	78	193	4
09-841-068	02-900-103	1 000	45	93	253	4

¹ For chemical and thermal resistance, see page 27.

The DURAN® YOUTILITY Screw Cap GL 45 is manufactured from a food-grade polypropylene (PP¹) and is fully reusable. Ergonomically shaped screw cap with optimized grooves and ridges for a more efficient and easier tightening or removal, especially with smaller sized or gloved hands. The faster opening and closing thread of the YOUTILITY screw cap is fully compatible with DIN GL 45 bottle threads. The optimized cap sealing system ensures a liquid tight seal. A pre-defined labelling area on the cap is compatible with the dedicated DURAN® self-adhesive YOUTILITY labels.

DURAN® YOUTILITY SCREW CAP GL 45

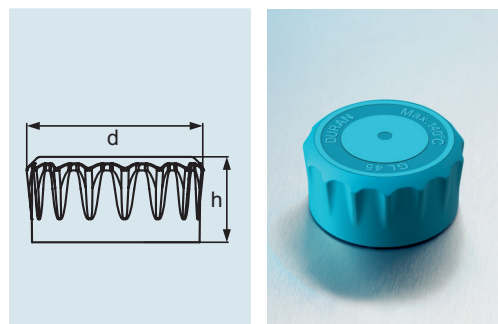

Cat. No.	Thread GL	Colour	d mm	h mm	Pack / Quantity
YOUTILITY Cap					
09-841-069	45	cyan	53	25	10
Pouring ring					
09-841-070	45	cyan		4	16

¹ For chemical and thermal resistance, see page 27.

The colourful silicone GL 45 Bottle Tags can be easily and securely attached around the neck of the YOUTILITY bottle. The Bottle Tags are available in several distinct colours for easy customization and unambiguous bottle identification. The elastic Bottle Tags will fit around any DIN GL 45 bottle neck, and can even be applied with the screw cap in place.

DURAN® BOTTLE TAG GL 45



Cat. No.	Colour	Pack / Quantity
09-841-071	Eight colours. Two silicone Bottle Tags are supplied in each colour	16

DURAN® YOUTILITY LABELS Self-adhesive

DURAN® YOUTILITY Labels are designed for use with the YOUTILITY bottle system. A pack contains 200 bottle and 200 screw cap labels. The white polyester labels are chemically resistant with a wide -40 °C to +150 °C performance range.

Cat. No.	Material and colour	Pack / Quantity
09-841-072	White polyester labels with heat sensitive indicator	1
09-841-315	White polyester labels, self-printable, 100 labels	1



DURAN® LABORATORY BOTTLE PRESSURE PLUS+ GL 45

The DURAN® pressure plus+ GL 45 bottles offer a safer option for laboratory applications involving vacuum or pressure. Standard glass laboratory bottles are not designed to safely withstand pressure differentials. As a result of a modified geometry, the pressure plus+ bottles have a guaranteed pressure-resistance, and consequently offer optimal safety for both the user and contents. Three versions of the pressure plus+ bottles are available; clear DURAN® glass with or without a protect plastic safety coating, and amber DURAN® glass for protection against ultraviolet light degradation.

Applications

- Vacuum filtration
- Collection of samples under pressure
- Storage of volatile solvents
- Storage of gas generating materials

Features

- Manufactured from DURAN® borosilicate 3.3 glass, renowned for its excellent thermal performance and high resistance to chemical attack.
- Available in four convenient sizes: 100, 250, 500 and 1000 ml.
- Vacuum resistance guaranteed to 1 bar vacuum.
- Pressure resistance guaranteed to +1.5 bar gauge.
- Pressure plus+ bottles are certified by the German Technical Inspection Association (TÜV) in accordance with DIN EN 1595:1997-05.

DURAN® laboratory bottle pressure plus+ features the industry standard GL 45 DIN thread.

- Blue ceramic printing clearly distinguish pressure plus+ from the DURAN® original GL 45 laboratory bottles.
- Bottles are fully autoclavable and sterilizable.
- Ambered glass meets UV light protection limits as specified in the current revisions of the USP <660> and EP 3.2.1.
- Protect coated version offers protection for the user and contents in the event of breakage due to impact.
- Special geometry still conforms to ISO 4796-1:2016 to maintain instrument compatibility.
- Manufacturing traceability is offered through a lot specific Retrace Code printed on the bottle.

Note: When pressure loaded the following apply: thermal shock resistance 30 K and maximum usage temperature is +140 °C.

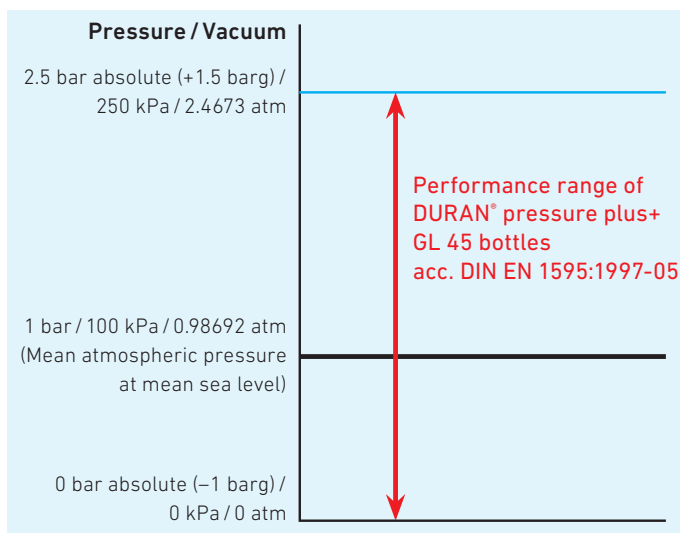

Pressure resistance conforms to DIN EN 1595, confirmed by GS marking (TÜV ID: 0000020716). Vacuum and/or pressure resistant from -1 to +1.5 bar due to modified geometry (based on ISO 4796-1). When pressure loaded the following applies: thermal shock resistance 30 K and maximum usage temperature +140 °C. Blue scale for visual differentiation from the standard laboratory bottle. With easy-to-read scale and large labelling field for easy marking, in fired-on, highly durable ceramic.

Typical applications: safe working under pressure or vacuum, sampling under pressure, storage of gas generating media.

Cat. No.	Capacity ml	DIN thread GL	d mm	h mm	Pack / Quantity
Without cap and pouring ring, clear					
14-209-168	100	45	56	100	10
09-841-001	250	45	70	138	10
09-841-002	500	45	86	176	10
09-841-003	1 000	45	101	225	10
Without cap and pouring ring, clear with Protect Plastic Coating					
14-209-170	100	45	56	100	10
14-209-174	250	45	70	138	10
14-209-175	500	45	86	176	10
14-209-176	1 000	45	101	225	10
Without cap and pouring ring, amber					
14-209-169	100	45	56	100	10
09-841-004	250	45	70	138	10
09-841-005	500	45	86	176	10
09-841-006	1 000	45	101	225	10

Bottle with plastic coating is available on demand.

With easy-to-read scale and large labeling field for easy marking in fired-on, highly durable ceramic ink. Complete system including DURAN® Pressure plus laboratory bottle with 4-port screw cap (PP), four screw connectors (black, M* thread) and silicone seals. Connection of different hose diameters; 1.6 mm and 3.2 mm as well as sterile pressure equalization sets. Unused ports can be sealed with silicone blanking seals.

Cat. No.	Capacity ml	DIN thread GL	d mm	h mm	Pack / Quantity
09-841-007	500	45	86	176	2
09-841-008	1 000	45	101	225	2
Accessories					
09-841-009	Screw cap HPLC, GL 45, 4 ports, complete ³				2
09-841-010	Spare part set ² for HPLC screw cap				1
09-841-011	Pressure compensation set 4-port cap (0.2 µm incl. membrane filter)				1
09-841-115	Spare membrane filter for pressure compensation set, 0.2 µm				2

¹ For chemical and thermal resistance, see page 27.

² Including silicone seals.

³ GL 45 screw cap, 4x M8 screw cap, 12 x silicone seals

DURAN® PRESSURE PLUS + LABORATORY BOTTLE¹ with DIN thread, GL 45

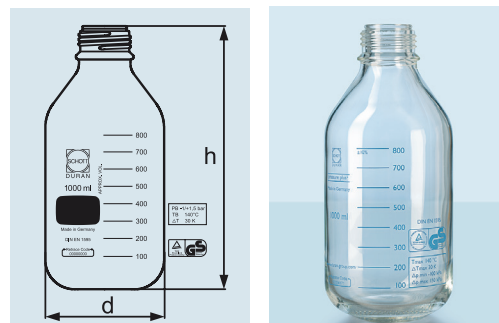

DURAN® HPLC BOTTLE with DIN thread GL 45



DURAN® ASPIRATOR BOTTLE

neck with DIN thread GL 45,
tabulator with GL 32

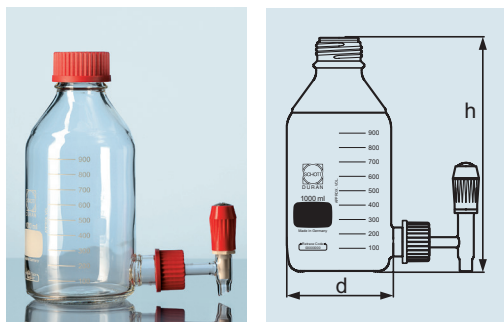

Complete with screw connection cap¹, silicone seal and stopcock with PTFE² spindle. Dosing of liquids is possible via a stopcock.

Cat. No.	Capacity ml	DIN thread GL	d mm	h mm	Pack / Quantity
02-900-129	1 000	45	101	225	1
02-900-130	2 000	45	136	260	1
02-900-131	5 000	45	182	330	1
02-900-132	10 000	45	230	410	1
Replacement Stopcocks					
02-913-041	For Capacity 1 + 2 L				1
02-913-042	For Capacity 5 + 10 L				1

¹ For chemical and thermal resistance, see page 27.

DURAN® GAS WASHING BOTTLE

Without filter disk



With filter disk



Without filter disk

With screw-connection system; the insertion height of the head is adjustable. Individual parts can also be ordered separately.

Cat. No.	Capacity ml	DIN thread GL	Hose Connection d mm	Pack / Quantity
02-913-043	500	45	9	1

With filter disk

With screw-connection system; the insertion height of the head is adjustable. The distribution of gas in the liquid is carried out through the filter disk and thus the absorption efficiency significantly increased. Gas washing bottles also work reliably at high flow rates.

Cat. No.	Capacity ml	DIN thread GL	Porosity	Bowl mm	Hose Connection d mm	Pack / Quantity
09-841-092	500	45	1	25	9	1

PREMIUM CAP

from TpCh260¹ (similar to PFA)
with PTFE¹ coated silicone seal²

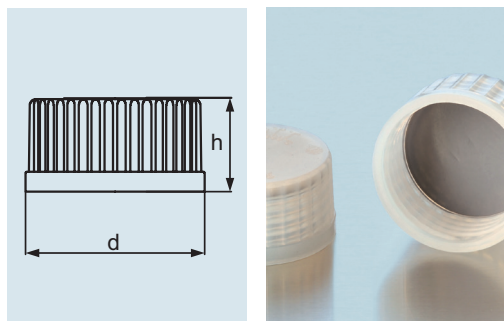

Compound formulated without colour dye to avoid risk of leaching. Service temperature limit from -196 °C to +200 °C. Very high chemical resistance. High leak tightness through use of PTFE¹ coated silicone seal. A matching TpCh260¹ pouring ring is also available, permitting clean, drop-free use.

Typical applications: due to its properties, ideal for applications in the pharmaceutical industry, handling of aggressive media, demanding sterilization processes such as hot air or dry sterilization and depyrogenation.

Cat. No.	DIN thread GL	Colour	d mm	h mm	Pack / Quantity
Cap					
09-841-276	25	colourless	32	22	5
09-841-062	45	colourless	51	26	5
Pouring ring					
09-841-063	45	colourless		4	5
Replacement sealing disc ²					
02-900-134	25	colourless	23,5	3,1	10
02-900-135	45	colourless	43,1	3,1	10

¹ For chemical and thermal resistance, see page 27.

² Platinum-cured silicone

High leak tightness through use of PTFE¹ coated silicone seal. More chemically resistant than PP¹ screw cap. A matching ETFE¹ pouring ring is also available, permitting clean, drip-free use.

Cat. No.	DIN thread GL	d mm	h mm	Pack / Quantity
Cap				
09-841-258	14	20	17	10
09-841-260	18	23	20	10
09-841-262	25	33	23	10
09-841-269	32	42	26	10
09-841-271	45	54	28	10
Pouring ring				
09-841-239	32		4	10
09-841-243	45		4	10

¹ For chemical and thermal resistance, see page 27.

Suitable for silicone seal for piercing (Septa).

Typical applications: injection or removal of media.

Cat. No.	DIN thread GL	Aperture bore d mm	Pack / Quantity
09-841-253	14	9,5	10
NC0650749	18	11	10
09-841-254	25	15	10
09-841-255	32	20	10
09-841-256	45	34	10

¹ For chemical and thermal resistance, see page 27.

Heat resistance: 130 °C (vapour) and 200 °C (dry heat). Good chemical resistance due to PTFE¹ coating, with peroxide-cured silicone.

Cat. No.	for screw caps, red GL	Pack / Quantity
09-841-275	14	10
02-900-139	18	10
02-900-140	25	10
02-900-141	32	10
NC9680248	45	10
09-841-312	45	10

¹ For chemical and thermal resistance, see page 27.

² Platinum-cured silicone

SCREW CAP from PBT¹, red

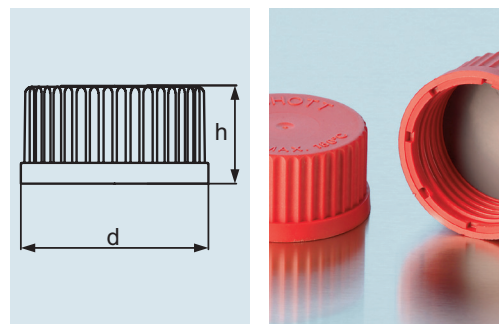

A	Tmax.
121 °C	180 °C

SCREW CAP WITH APERTURE from PBT¹, red

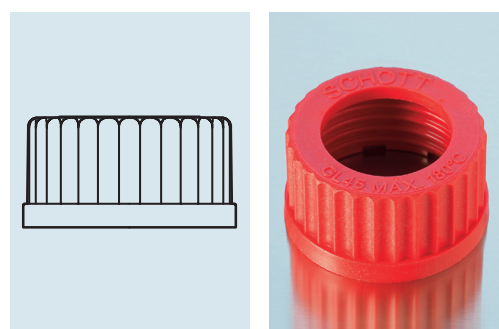

A	Tmax.
121 °C	180 °C

SILICONE SEAL PTFE¹ coated (VMQ¹)

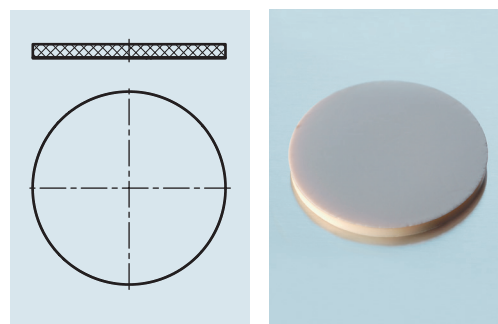

A	Tmax.
121 °C	200 °C

SILICONE SEAL (Septa) VMQ¹, for piercing

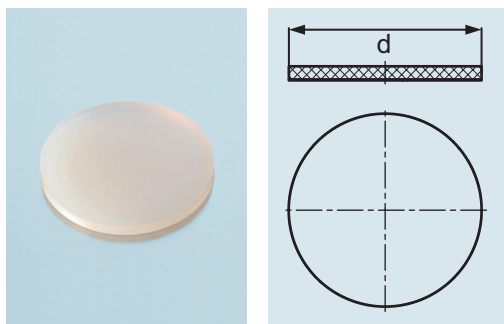

A	Tmax.
121 °C	200 °C

Suitable for PBT¹ screw cap with aperture. Heat resistance: 130 °C (vapour) and 200 °C (dry heat). Silicone is peroxide-cured.

Typical applications: injection or removal of media.

Cat. No.	for DIN thread GL	d mm	Thickness mm	Pack / Quantity
02-900-142	14	12	2	100
09-841-237	18	16	2	100
NC0852241	25	22	2	100
02-900-143	32	29	2	100
NC0852231	45	42	3	100

¹ For chemical and thermal resistance, see page 27.

CONNECTION SYSTEM

screw cap GL 45 with two or three ports
PP¹ and PTFE¹

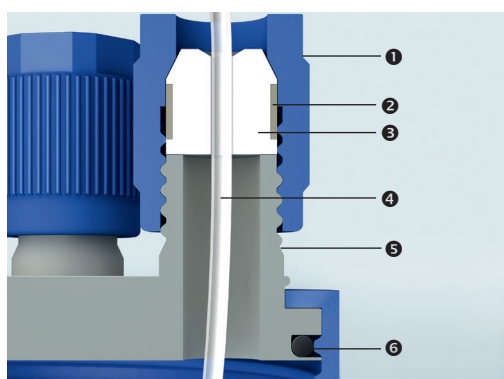

Schematic diagram of GL 45 connection system

- ① Screw cap GL 14 (PP)
- ② Silicone sealing ring on insert
- ③ PTFE insert / tubing connector
- ④ Tubing (not supplied)
- ⑤ Port (PP)
- ⑥ O-ring seal

Flexible modular system. Four different hose diameters (1.6 mm; 3.0 mm; 3.2 mm and 6.0 mm) can be connected. Sterile pressure equalization is possible through use of membrane filter. Unused ports can be provided with a blind cap.

Typical applications: safe transfer of liquid media within a closed and sterile system (evaporation is reduced).

Cat. No.	Description	DIN thread GL	Pack / Quantity
09-841-110	Screw cap GL 45, PP ¹ , 2 ports GL 14	45	2
09-841-111	Screw cap GL 45, PP ¹ , 3 ports GL 14	45	2
09-841-112	Screw cap GL 14 PP ¹ , for hose connection	14	2
09-841-116	Insert for screw cap GL 14, 1.6 mm (1/16 inch) ID		1
09-841-117	Insert for screw cap GL 14, 3.0 mm (~1/8 inch) ID		1
09-841-118	Insert for screw cap GL 14, 3.2 mm (1/8 inch) ID		1
09-841-119	Insert for screw cap GL 14, 6.0 mm (~1/4 inch) ID		1
09-841-113	Screw cap, PBT ¹ , with PTFE ¹ coated seal, red, GL 14	14	2
09-841-114	Set for pressure compensation 2- and 3-port screw cap (incl. 0.2 µm membrane filter), GL 14		1
09-841-115	Spare membrane filter for pressure compensation, 0.2 µm		2

¹ For chemical and thermal resistance, see page 27.

Ideal for the connection of elastic, soft tubing, which, for example, is used in biotechnology when transferring media with the aid of peristaltic pumps. The curved hose connections prevent kinking of the tubing. The grey PP core moves freely and allows the vessel to be changed without twisting of the firmly attached tubing. Sterile pressure equalization is possible through use of membrane filter.

Typical applications: safe transfer of liquid media within a closed and sterile system (evaporation is reduced).

Cat. No.	Description	Pack / Quantity
09-841-264	GL 45 screw cap with 2 hose connections	2
09-841-265	Filter top part for pressure equalization	2
02-900-144	Syringe Filter Connector (without syringe filter) Female Luer Slip to 5.8 mm male connector with o-ring seal	2

¹ For chemical and thermal resistance, see page 27.

CONNECTION SYSTEM

screw cap GL 45 with two hose connections
PP¹

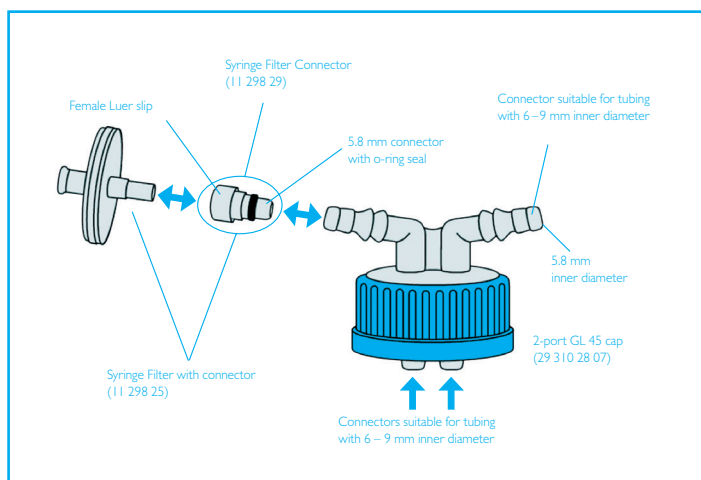

DURAN® BAFFLED, WIDE MOUTH BOTTLE GLS 80®

During mixing in standard GLS 80 laboratory bottles, the liquid moves in a swirling motion that approximates a solid-body rotation. The entire fluid, and any suspended particles, moves like a carousel. This is a very inefficient flow pattern, and very little mixing actually occurs. By adding three vertical baffles into the inner surface of the GLS 80 bottles, the swirling motion is disrupted, and a much more effective mixing occurs. The baffles improve the top-to-bottom circulation and produce a greater radial mixing. The baffles also offer other advantages such as suppressing the formation of a central vortex, and reducing dead-zones where mixing does not occur.

Applications

- Aerating
- Dissolving
- Emulsifying
- Homogenizing
- Mixing
- Suspending

Features

- The baffled GLS 80 bottles are fully compatible with both the DURAN® GLS 80 magnetic stirrers, and other magnetic stir bars.
- Manufactured from DURAN® borosilicate 3.3 glass, renowned for its excellent thermal performance and high resistance to chemical attack.
- The baffled GLS 80 bottles are fully autoclavable.
- Available in three convenient sizes: 250, 500 and 1000 ml.
- The wide 65 mm inner diameter of the GLS 80 wide mouth provides easy access to the contents, or for cleaning.
- The baffles are moulded into the glass side wall of the bottles and form a continuous, smooth inner surface making clean up easy.
- Compatible with full range of wide mouth GLS 80 connection cap systems for liquid addition or removal when mixing with stir bars.
- The bottles feature an easy-to-read graduated volume scale.



Cat. No.	Capacity ml	DIN thread GLS	d mm	h mm	Pack / Quantity
14-209-171	250	80	95	105	1
14-209-172	500	80	101	152	1
14-209-173	1 000	80	101	222	1

Optional accessories

Cat. No.	Description	Pack / Quantity
02-900-165	GLS 80 blue polypropylene vented cap	2
02-900-160	Stirred reactor wide mouth cap for 250 ml bottle, GLS 80 supplied with impeller shaped magnetic stirrer, 4 connection ports (2x GL 18 and 2x GL 14)	1
09-841-015	Stirred reactor wide mouth cap for 500 or 1000 ml bottles, GLS 80 supplied with anchor shaped magnetic stirrer, 4 connection ports (2x GL 18 and 2x GL 14)	1

DURAN® baffled wide mouth bottles GLS 80® must be ordered separately.

DURAN® DOUBLE WALLED, WIDE MOUTH BOTTLE GLS 80®

The DURAN® double walled, wide mouth bottles GLS 80 incorporate an integral jacket that isolates the contents from the external environment. Heated or cooled liquids can be circulated through the jacket to control the temperature within the screw topped DURAN® bottle. The DURAN® double walled bottles offer a sealable and more flexible alternative to open topped jacketed beakers.

Applications

- Simple, low cost, jacketed chemostat or bioreactor for cell culture.
- Vessel for temperature-controlled reactions such as enzyme digestions.
- Simple continuous flow stirred reactor system with the optional GLS 80 cap components.
- Thermostatic vessel to maintain fluids, or high viscosity liquids at a constant temperature, useful when working with endo- or exothermic reagents.
- Large cold trap or condenser when used with dry ice in the inner container.

Features

- Wide usable temperature range of -40 to $+120$ °C. The range can be extended from -45 to $+180$ °C with the optional white GLS 80 polyethersulfone cap. DURAN® glass components are usable from -196 to $+300$ °C, but care must be taken to limit the rates of heating or cooling.
- Manufactured from DURAN® borosilicate 3.3 glass, renowned for its excellent thermal performance and high resistance to chemical attack.
- All components are fully autoclavable.
- Available in two convenient sizes: 500 and 1000 ml.
- The wide 65 mm inner diameter of the GLS 80 wide mouth provides easy access to the contents, or for cleaning.
- The flat inner base is compatible with magnetic stir bars, or the GLS 80 magnetic stirrer cap system.
- Compatible with full range of wide mouth GLS 80 connection cap systems for liquid addition or removal during processing.
- The inner vessel features an easy-to-read graduated volume scale.
- The GL 18 outlet hose connectors are removable for increased safety.
- The positions of the 10 mm PTFE inlet / outlet hose connectors are optimized for a uniform flow around the jacket to ensure consistent heating or cooling.



Cat. No.	Capacity ml	DIN thread GLS	d mm	h mm	Pack / Quantity
02-900-161	500	80	110	170	1
02-900-162	1 000	80	110	270	1

The maximum pressure in the double walled glass jacket must not exceed +50 kPa gauge. These products must not be used under vacuum.

DURAN® DOUBLE WALLED, WIDE MOUTH BOTTLE GLS 80®

Available closure options include:



DURAN® double walled bottles must be ordered separately

Closure systems and accessories

Cat. No.		Description	Pack / Quantity
09-841-274	1	GLS 80 white polyethersulfone (PSU) cap with PTFE coated cap liner for higher temperature applications	5
02-900-165	2	GLS 80 blue polypropylene vented cap	2
09-841-015	3	Stirred reactor wide mouth cap, GLS 80 supplied with anchor shaped magnetic stirrer, 4 connection ports (2x GL 18 and 2x GL 14)	1
02-900-163	4	Mixing and connection wide mouth Cap GLS 80 includes KPG stirrer shaft 10 mm diameter and 410 mm in length and 4 connection ports (Supplied with 2x GL 18 and 2x GL 14 screw caps)	1

QUICK RELEASE CLOSURE FOR DURAN® GLS 80® LABORATORY BOTTLE

from PP¹, blue, with lip seal

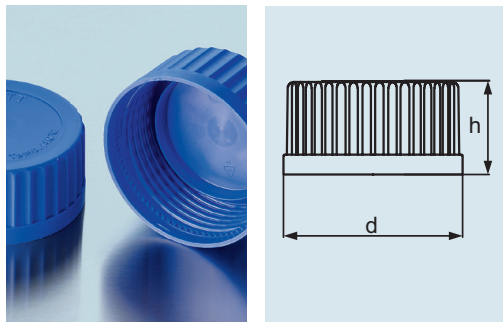

A	Tmax.
121 °C	140 °C

Permits opening and closing of the DURAN® GLS 80 bottle with only a three-quarter turn. A matching PP¹ pouring ring is also available, permitting clean, drop-free use.

Cat. No.	Thread GLS	d mm	h mm	Pack / Quantity
Cap				
09-841-273	80	87	40	10
Pouring ring				
09-841-245	80		6.85	10

¹ For chemical and thermal resistance, see page 27.

QUICK RELEASE CLOSURE FOR DURAN® GLS 80® LABORATORY BOTTLE

with sealing disc (PSU compound¹)

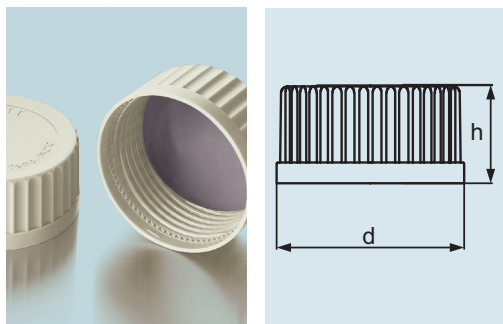

A	Tmax.
121 °C	180 °C

The material used is a special compound based on a polyarylsulphone¹. Consequently the chemical, thermal and mechanical properties of the material are noticeably improved and matched to laboratory requirements. Thanks to the thread, the DURAN® GLS 80 bottle can be opened and closed with only a three-quarter turn. The seal, which is coated on both sides with PTFE¹, ensures the bottle can be tightly closed. A matching PTFE¹ pouring ring is also available, permitting clean, drop-free use.

Cat. No.	Thread GLS	d mm	h mm	Pack / Quantity
Cap				
09-841-274	80	88.5	40	5
Pouring ring				
09-841-246	80		6.85	5
Replacement sealing disc				
02-913-040	80	79	3.1	5

¹ For chemical and thermal resistance, see page 27.

MEMBRANE SCREW CAP FOR DURAN® GLS 80® LABORATORY BOTTLE

from PP¹, blue, with welded-in PTFE¹
membrane for pressure equalization

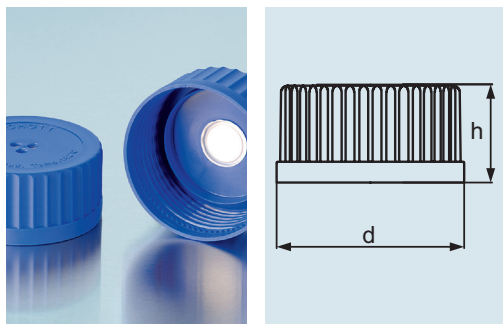

A	Tmax.
121 °C	140 °C

For GLS 80 thread. Ideal for autoclaving processes because the membrane permits pressure equalization and tight sealing. Hence the risk of contamination is greatly reduced. Ingress of liquids or solids is prevented and the bottle contents remain sterile.

Typical applications: storage or transport of gas generating media, autoclaving of media.

Cat. No.	Thread GLS	d mm	h mm	Pack / Quantity
02-900-165	80	86	40	2

¹ For chemical and thermal resistance, see page 27.

Materials used: PP¹ and PTFE¹. Flexible modular system. Five different hose diameters (3.2 mm; 6.0 mm; 8.0 mm; 10.0 mm and 12.0 mm) can be connected. Sterile pressure equalization is possible by using the membrane filter. Unused ports can be provided with a blind cap.

Typical applications: safe transfer of liquid media within a closed and sterile system (evaporation is reduced).

Cat. No.	Thread GLS	d mm	h mm	Pack / Quantity
09-841-314	80	86	~60	2
Accessories				
09-841-143	Insert for screw cap GL 18, ID 3.2 mm			1
09-841-144	Insert for screw cap GL 18, ID 6.0 mm			1
09-841-145	Insert for screw cap GL 18, ID 8.0 mm			1
09-841-146	Insert for screw cap GL 18, ID 10.0 mm			1
09-841-147	Insert for screw cap GL 18, ID 12.0 mm			1
09-841-259	Screw cap for tube connection, blue, GL 18			2
02-900-166	Pressure equalization set for 4-port, GL 18			1
09-841-257	Screw cap, red, PBT ¹ , GL 18			2

¹ For chemical and thermal resistance, see page 27.

GLS 80® CONNECTION SYSTEM screw cap GLS 80® with four ports (GL 18 thread)

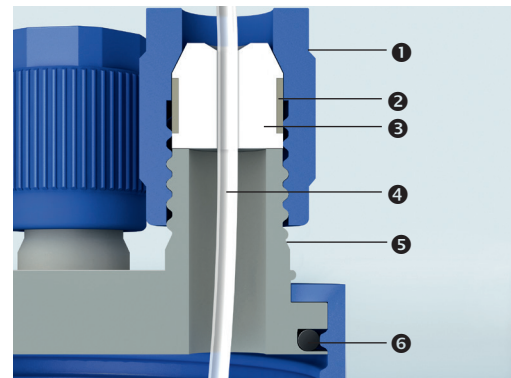

Schematic diagram of GLS 80® connection system

- ❶ Screw cap GL 18 (PP)
- ❷ Silicone sealing ring on insert
- ❸ PTFE insert / tubing connector
- ❹ Tubing (not supplied)
- ❺ Port (PP)
- ❻ O-ring seal

ORDERING

DURAN laboratory products are available from DWK Life Sciences directly or through our authorized distribution partners. Please visit our website at www.wheaton.com to learn more about our products, services, or locate an authorized distribution partner. If you would like to purchase directly from us; please visit our website or call us directly at:

US & Canada	1-800-225-1437
International	1-856-825-1100
Worldwide Fax	1-856-825-1368

PRODUCT INFORMATION & SPECIFICATIONS

The product information and specifications shown in this catalog were accurate at the time of publication, but are subject to change without notice. For current information please visit our website or contact our customer service department with requests for products which differ from those shown in this catalog. We have a wide range of manufacturing capabilities, and we would be glad to discuss a solution for your business need.

In accordance with our policy for continuous improvement to the design of our products or manufacturing techniques, purchasers may notice that items ordered and received may differ from the description and/or photograph of that product appearing in this catalog.

U.S. DEPARTMENT OF COMMERCE

We are prohibited from shipping any of our products to purchasers in countries listed on the United States embargo list. For a list of these countries please refer to the U.S. Department of Commerce website.

EXCHANGES OR RETURNS

All exchanges, replacements or returns are subject to the applicable terms and conditions based on the point of purchase.

To ensure prompt handling, all exchanges, replacements or return of goods purchased directly from DWK Life Sciences should be processed within 90 days of purchase, and returns require prior approval and are subject to 25% restocking fee. Prior to returning any product, please call customer service at 1-800-225-1437 to obtain an authorized RGA number. Returns and exchanges must be returned in the original packaging, freight prepaid.

DAMAGE IN SHIPMENT

All shipments should be opened immediately upon receipt for inspection for concealed damages. If concealed damage is discovered, hold the shipping container and packaging materials and immediately request that the carrier make an inspection. If you find damage or shortages, do not accept the shipment until the carrier makes a notation on your delivery receipt or freight bill. All requests for inspection must be made to the carrier within 15 days of receipt of shipment. All claims for damages must be made against the carrier.

WARRANTIES

All goods and materials shall conform to DWK Life Sciences specifications at the time of shipment from our plant. At our option, we will either correct the non-conforming condition or replace any nonconforming goods or materials or issue you a credit in the amount of the purchase price paid for such goods. Notification of any claims of nonconformity must be made within ten (10) days after the discovery of any such defect. Before any claim of nonconformity will be honored, DWK Life Sciences must be given an opportunity, after receiving notice of your claim, to inspect the goods or materials claimed to be nonconforming. Unless otherwise stated, any claim for a breach of warranty shall not be made later than six (6) months after the date of delivery of the goods and materials.

We make no other express or implied warranty, statutory or otherwise, concerning materials or goods supplied, including without limitation, any warranty of fitness for a particular purpose or any warranty of merchantability. The warranties given hereunder are exclusively in lieu of all other warranties express or implied. We shall not be liable for consequential, special or incidental damages.

We make no warranty, express or implied, with respect to defects in or nonconformity of goods or materials resulting from designs or specifications provided by you. Technical advice is furnished as an accommodation to you. We assume no liability for technical advice and you accept such advice at your sole risk.

Copyright © 2018 DWK Life Sciences All rights reserved.

VISIT WWW.DWK-LIFESCIENCES.COM FOR MORE DETAILED INFORMATION ON THE ABOVE TOPICS.

BOTTLES

Laboratory bottles

DURAN® laboratory bottles are chemically resistant and stable. The extensive range of original accessories includes screw caps for the widest possible range of applications. Alongside the standard PP screw cap for everyday laboratory use, further caps made from various plastics and having special properties are available. DURAN® laboratory bottles are completed by suitable pouring rings from different plastics, which enable drip-free working. As almost all GL 45 bottles of 100 ml capacity and above use the same thread size, screw caps and pouring rings are fully interchangeable. The bottles, pouring rings and caps are autoclavable/ sterilizable.

Properties

Light protection

- amber bottles are opaque up to 500 nm
- plastic coated bottles are opaque up to 380 nm
- Application: storage of light sensitive substances

High thermal shock resistance

Due to their temperature properties, the bottles are suitable for autoclaving and sterilizing. Because of the bottom geometry and the wall thickness, direct heating with an unshielded flame is not recommended. When using an electronic heating plate or water bath laboratory bottles should be heated gradually.

Recommendations

Pressure resistance

DURAN® laboratory bottles are, with the exception of the pressure-resistant DURAN® pressure plus + bottles, in general not suitable for use under pressure or in a vacuum. DURAN® pressure plus + bottles are pressure resistant from -1 to +1.5 bar (overpressure) due to a modified geometry and increased wall thickness.

Sterilization

When sterilizing or autoclaving contents, the screw cap must only be loosely fitted (max. one turn). The contents may expand or boil causing a large pressure difference in a closed vessel, which may well result in explosive failure. Alternatively, a DURAN® membrane cap may be used. Pressure equalization takes place through the PTFE membrane, while at the same time the membrane cap can remain tightly closed, greatly reducing the risk of contamination.

Cleaning

Cleaning should be carried out manually in a soaking bath or automatically in a dishwasher. When cleaning in a dishwasher, load so that there is no glass-to-glass contact (especially the threads) to avoid chips or abrasions.

Freezing substances

Recommendation: The bottle should be frozen slanted at an angle of 45°, filled to a maximum 3/4 (to enlarge the surface area) and dependent on the properties of any screw caps or other components used. For the blue PP screw cap the minimum temperature is -40 °C. Alternatively the Premium screw cap can be used (min. working temperature: -196 °C).

Thawing frozen substances

Frozen contents can be thawed by immersing the bottle in a liquid bath while taking care that the temperature difference between the contents and the bath does not exceed $\Delta T = 100\text{K}$. This will ensure that the frozen material is warmed uniformly from every side without damaging the bottle. The contents can, however, also be thawed slowly from above, so that the surface melts first, allowing the material to expand.

Laboratory bottles with plastic coating

The coating of DURAN® Protect bottles is a resistant and transparent plastic coating based on a cross-linked copolymer. The coating adheres securely to the glass surface and fulfils the following functions:

- Protects the glass surface against mechanical damage (scratch protection).
- Holds the fragments together in the event of the glass breaking (splinter protection).
- Minimises liquid loss if the glass breaks (protects against contents escaping and splash).
- Absorbs UV rays up to a light wavelength of 380 nm (light protection).

Recommendations

- The plastic coating does not increase the pressure resistance. These bottles are not designed for pressure or vacuum applications.
- If the plastic coated bottle breaks during use, the contents and the plastic coating are likely to come into contact. A test for any interaction between plastic and contents should be carried out to ensure that the contents remain unchanged and can be further used.

Temperature resistance

Do not expose DURAN® protect bottles to open flames or direct heat, e.g. on a laboratory hotplate. The maximum operating temperature is +135 °C and thus the bottle is suitable for use in an autoclave. Long-term exposure to temperature (> 30 minutes) should be avoided. DURAN® protect bottles can be used for freezing to -30 °C and used in microwaves. Thermal and chemical stresses can result in coating discolouration.

Autoclaving

The following procedure, bearing in mind the maximum temperature resistance, is recommended:

- Steam sterilization at +121 °C or +134 °C.
 - The cycle duration should not exceed 20 minutes at 15 psig.
- When sterilizing, the screw cap should only be loosely applied (max. one turn – do not tighten), or use a membrane cap that allows pressure equalization.

Laboratory glassware and plastics

Plastics used with laboratory glass¹

To complement DURAN® laboratory glassware products, various plastic products such as screw caps are available. Their properties are listed in the following table.

		Temperature resistance range °C
EPDM	Ethylene/propylene-diene-rubber	-45 to +150
ETFE	Partially crystalline ethylene / tetrafluoroethylene copolymer	-100 to +180
EVA	Ethylene-vinyl-acetate	-80 to +70
FEP	Tetra-Fluor-Ethylen/Hexafluor-Propylene	-200 to +200
FKM	Fluorinated rubber	-20 to +200
PBT ²	Polybutylenterephthalat	-45 to +180
PE	Polyethylene	-40 to +80
POM	Polyoxymethylene	-40 to +90
PP	Polypropylene	-40 to +140
PTFE	Polytetrafluorethylene	-200 to +260
PU ³	Polyurethane	-30 to +135
SBE	Styrene Butadiene Rubber	-30 to +70
TpCh260	Thermoplastic/duroplastic	-196 to +260
TPE	Thermoplastic – thermosetting plastic	to 140
VMQ	Silicone rubber	-50 to +200
PSU Compound	Compound polyarylsulfone based	-45 to +180

¹The details in the table relating to temperature resistance relate to standard autoclaving processes with steam and a duration of 20 minutes

²Changes in colour may occur if exposed to temperatures above 180 °C.

³All laboratory glasses coated with PU may only be cleaned while moist in order to avoid any electrostatic charge which may form.

Chemical resistance of plastics

Classes of substances +20 °C	PE	PP	PBT	PTFE/ FEP	TpCh260	ETFE	VMQ	EPDM	PU	FKM	POM	PSU Compound
Alcohols, aliphatic	+	+	++	++	++	++	+	+	++	-	+	++
Aldehydes	+	+	++	++	++	++	+		++		+	+
Alkaline solutions	++	++	+	++	++	++	-	++	++	-	+	++
Esters	+	+	+	++	++	++	-	++	+	-	-	+
Ethers	-	-	+	++	++	++	-	-	+	-	+	+
Hydrocarbons, aliphatic	-	+	+	++	++	++	-	++	++	++	+	+
Hydrocarbons, aromatic	-	+	+	++	++	++	-	+	++	++	+	-
Hydrocarbons, halogenated	-	+		++	++	++	-	+	-	++	+	-
Ketones	+	+	+	++	++	+	-	++	+	-	+	-
Acids, dilute or weak	+	++	++	++	++	++	-	++	++	++	-	++
Acids, conc. or strong	+	+	+	++	++	++	-	++	+	++	-	++
Acids, oxidising	-	+	-	++	++	+	-	-	+	+	-	+

++ = very good resistance

+ = good to limited resistance

- = low resistance

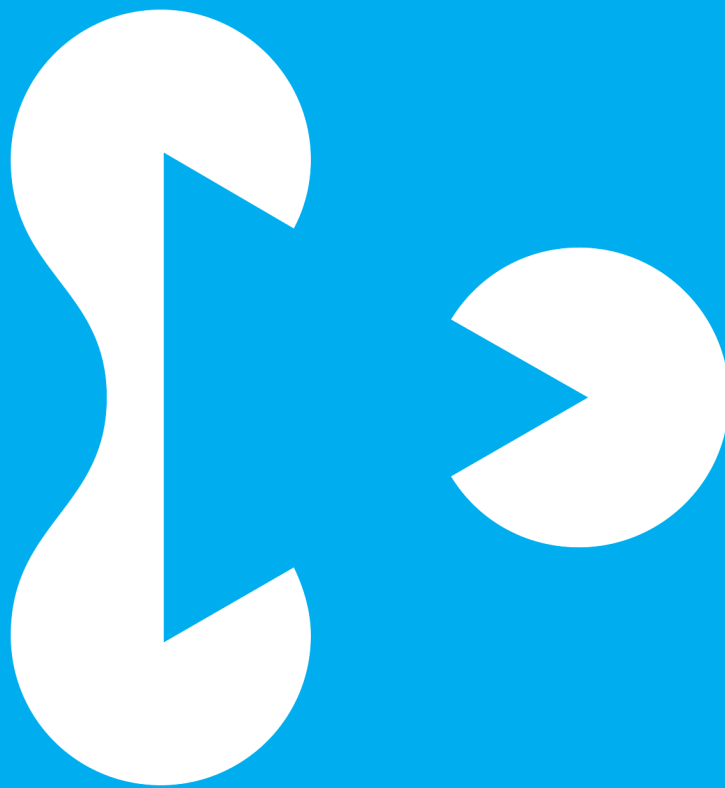

Copyright © 2018 DWK Life Sciences. Printed in USA.
FBR0_020 05/2018

In the United States:

For customer service, call 1-800-766-7000
To fax an order, use 1-800-926-1166
To order online: fishersci.com

In Canada:

For customer service, call 1-800-234-7437
To fax an order, use 1-800-463-2996
To order online: fishersci.ca



© 2018 Thermo Fisher Scientific Inc. All rights reserved.
Trademarks used are owned as indicated at fishersci.com/trademarks.

BN20181344