



spinbar[®]
The World's First Name in Magnetic Stirring

Magnetic Stirring Bar Actual Size Guide

Note: Actual size is correct when document printed at 100%; may render differently on computer screens

Spinbar® Octagon with Pivot Ring

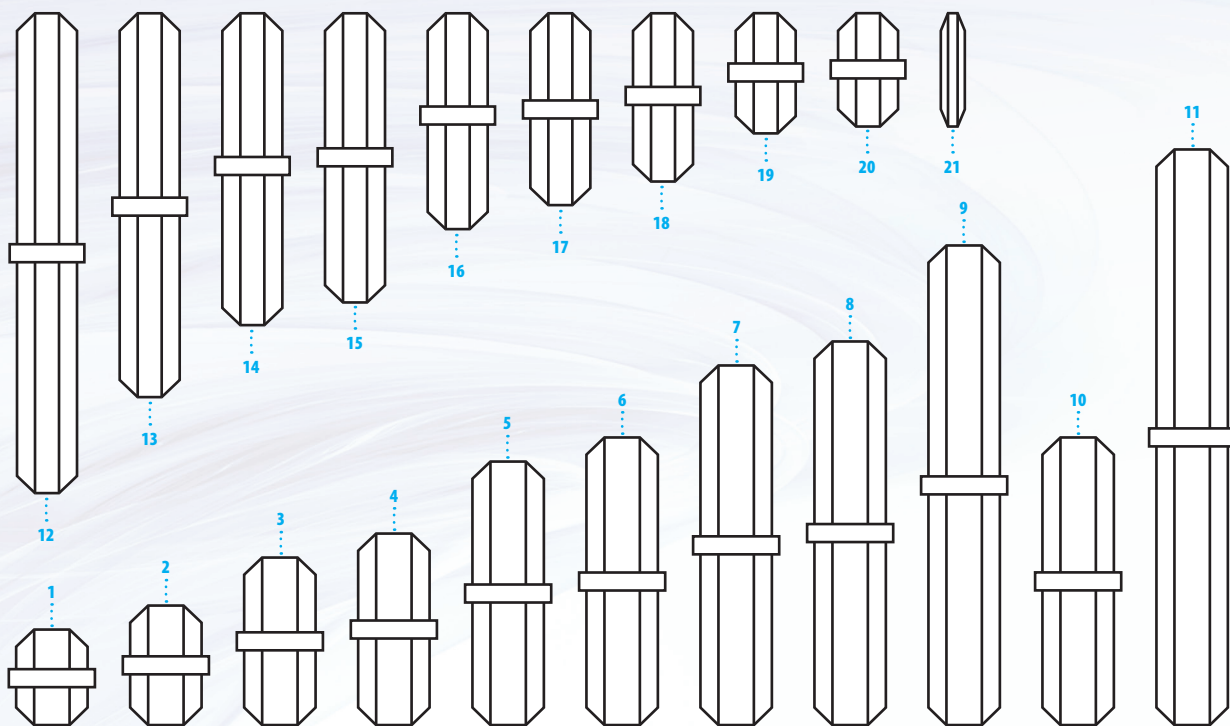

CATALOG NO.	DIMENSIONS (L X DIAM.)
1. F37110-1238	1/2 X 3/8" (12.7 x 9.5mm)
2. F37110-5838	5/8 X 3/8" (15.9 x 9.5mm)
3. F37110-7838	7/8 X 3/8" (22.2 x 9.5mm)
4. F37110-0138	1 X 3/8" (25.4 x 9.5mm)
5. F37110-1388	1 ³ / ₈ X 3/8" (34.9 x 9.5mm)
6. F37110-1128	1 ¹ / ₂ X 3/8" (38.1 x 9.5mm)
7. F37110-0178	1 ⁷ / ₈ X 3/8" (47.6 x 9.5mm)
8. F37110-0238	2 X 3/8" (50.8 x 9.5mm)
9. F37110-2128	2 ¹ / ₂ X 3/8" (63.5 x 9.5mm)
10. F37110-1122	1 ¹ / ₂ X 1/2" (38.1 x 12.7mm)
11. F37110-0003	3 X 1/2" (76.2 x 12.7mm)
12. F37110-0212	2 ¹ / ₂ X 5/16" (63.5 x 8mm)
13. F37110-0002	2 X 5/16" (50.8 x 8mm)
14. F37110-0158	1 ⁵ / ₈ X 5/16" (41.3 x 8mm)
15. F37110-0112	1 ¹ / ₂ X 5/16" (38.1 x 8mm)
16. F37110-0118	1 ¹ / ₈ X 5/16" (28.6 x 8mm)
17. F37110-0001	1 X 5/16" (25.4 x 8mm)
18. F37110-0078	7/8 X 5/16" (22.2 x 8mm)
19. F37110-0058	5/8 X 5/16" (15.9 x 8mm)
20. F37110-1256	1/2 X 5/16" (12.7 x 8mm)
21. F37110-1218*	1/2 x 1/8" (12.7 x 3.2mm)

Octagon Bars – Colors Cross Reference

WHITE BAR	RED EQUIVALENT	YELLOW EQUIVALENT	BLUE EQUIVALENT	GREEN EQUIVALENT (RARE EARTH)
F37110-0001	F37109-0010	F37109-0011	F37109-0012	N/A
F37110-0002	F37109-0028	F37109-0029	F37109-0030	N/A
F37110-0003	F37109-0031	F37109-0032	F37109-0033	F37102-0003
F37110-0058	F37109-0004	F37109-0005	F37109-0006	N/A
F37110-0078	F37109-0007	F37109-0008	F37109-0009	N/A
F37110-0112	F37109-0019	F37109-0020	F37109-0021	N/A
F37110-0118	N/A	N/A	N/A	N/A
F37110-0138	N/A	N/A	N/A	F37102-0138
F37110-0158	N/A	N/A	N/A	N/A
F37110-0178	N/A	N/A	N/A	N/A
F37110-0212	N/A	N/A	N/A	N/A
F37110-0238	N/A	N/A	N/A	F37102-0238
F37110-1122	N/A	N/A	N/A	N/A
F37110-1128	N/A	N/A	N/A	N/A
F37110-1218	F37109-0034	F37109-0035	F37109-0036	N/A
F37110-1238	N/A	N/A	N/A	F37102-1238
F37110-1256	F37109-0001	F37109-0002	F37109-0003	N/A
F37110-1388	N/A	N/A	N/A	N/A
F37110-2128	N/A	N/A	N/A	N/A
F37110-5838	N/A	N/A	N/A	N/A
F37110-7838	N/A	N/A	N/A	N/A

*No Pivot Ring

- Assured Quality
- Alnico V Permanent Magnet
- Seamless Molded TEFLON®
- Polished Finish
- Leakproof Design
- FDA Approved Materials
- Specified Tolerance of TEFLON® Walls
- High Strength Magnetization

Note: Actual size is correct when document printed at 100%; may render differently on computer screens

Spinbar® Cylindrical with Removable Pivot Ring

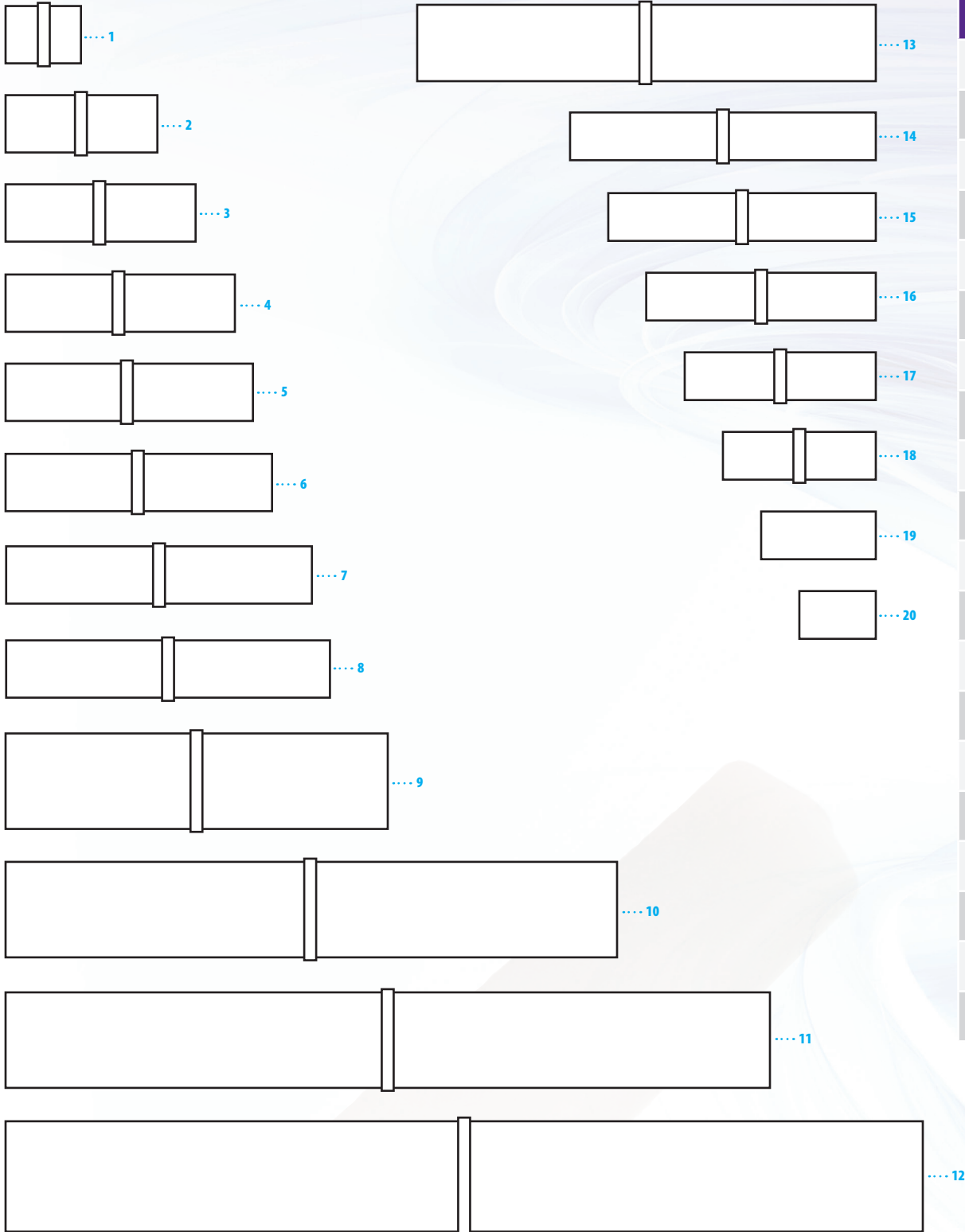

CATALOG NO.	DIMENSIONS (L X DIAM.)
1. F37111-1238	1/2 x 3/8" (12.7 x 9.5mm)
2. F37111-0138	1 x 3/8" (25.4 x 9.5mm)
3. F37111-1148	1 1/4 x 3/8" (31.8 x 9.5mm)
4. F37111-1128	1 1/2 x 3/8" (38.1 x 9.5mm)
5. F37111-0158	1 5/8 x 3/8" (41.3 x 9.5mm)
6. F37111-1348	1 3/4 x 3/8" (44.5 x 9.5mm)
7. F37111-0238	2 x 3/8" (50.8 x 9.5mm)
8. F37111-0218	2 1/8 x 3/8" (54.0 x 9.5mm)
9. F37111-2125	2 1/2 x 5/8" (63.5 x 16mm)
10. F37111-0004	4 x 5/8" (101.6 x 16mm)
11. F37111-0005	5 x 5/8" (127.0 x 16mm)
12. F37111-0006	6 x 3/4" (152.4 x 19mm)
13. F37111-0003	3 x 1/2" (76.2 x 12.7mm)
14. F37111-0002	2 x 5/16" (50.8 x 8mm)
15. F37111-0134	1 3/4 x 5/16" (44.5 x 8mm)
16. F37111-0112	1 1/2 x 5/16" (38.1 x 8mm)
17. F37111-0114	1 1/4 x 5/16" (31.8 x 8mm)
18. F37111-0001	1 x 5/16" (25.4 x 8mm)
19. F37111-0034*	3/4 x 5/16" (19.1 x 8mm)
20. F37111-0012*	1/2 x 5/16" (12.7 x 8mm)

*No Pivot Ring

Spinbar® Cell Bar



CATALOG NO.	DIMENSIONS (DIAM. X H)
F37150-0000	9 x 8mm

Spinbar® Round with Tapered Ends



CATALOG NO.	DIMENSIONS (L X DIAM.)
1. F37113-0208	0.787 x 0.315" (20 x 8mm)
2. F37113-0309	1.181 x 0.354" (30 x 9mm)
3. F37113-0409	1.575 x 0.354" (40 x 9mm)
4. F37113-0509	1.969 x 0.354" (50 x 9mm)

Note: Actual size is correct when document printed at 100%; may render differently on computer screens

Spinbar® Polygon Metric Units, No Pivot Ring

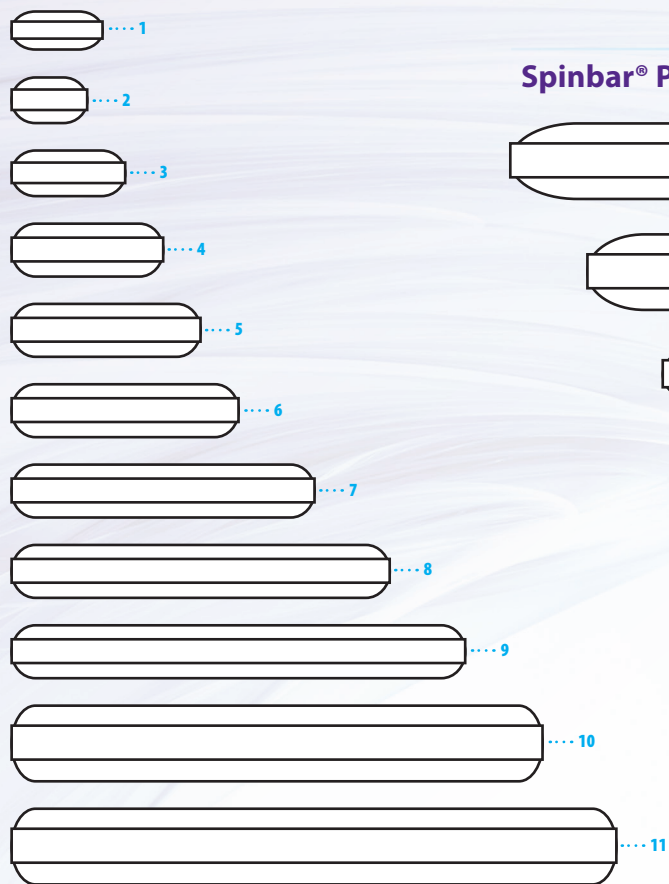

Spinbar® Polygon with Pivot Ring

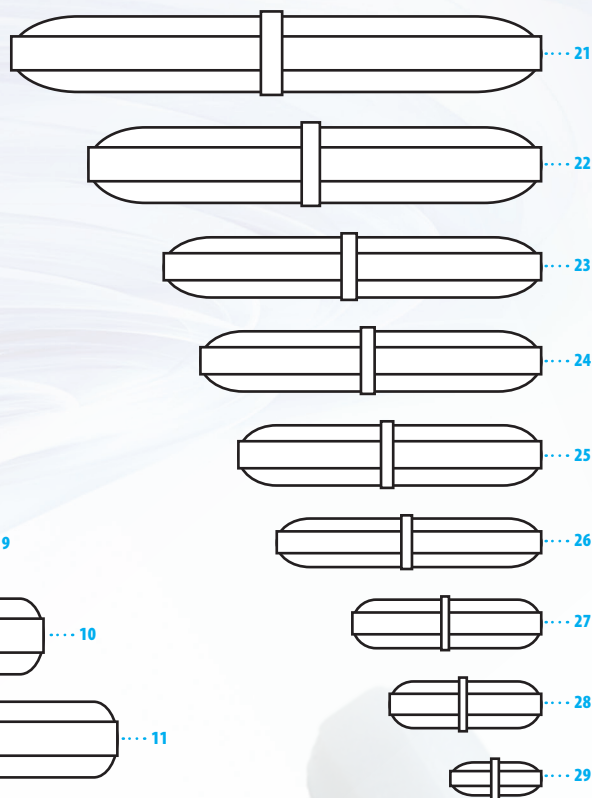

Spinbar® Polygon English Units, No Pivot Ring

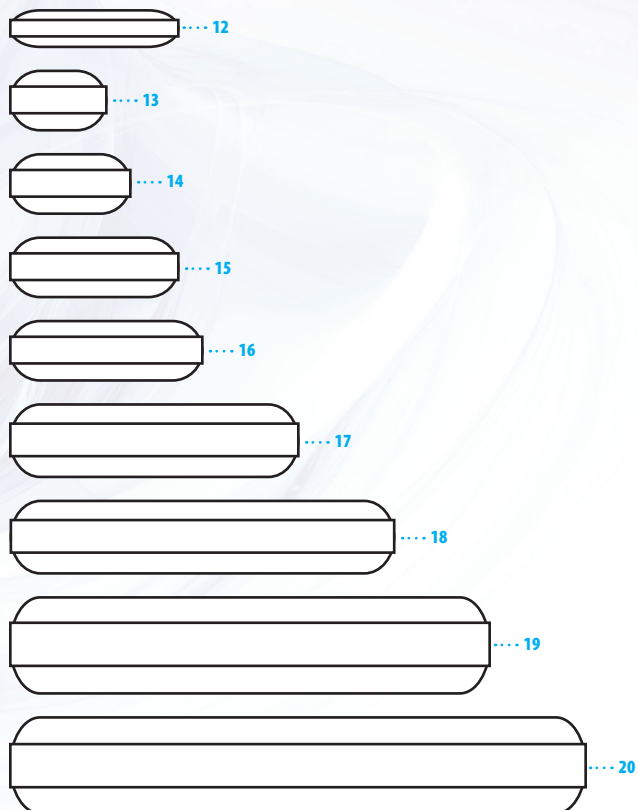

CATALOG NO.	DIMENSIONS (L X DIAM.)
METRIC UNITS, NO PIVOT RING	
1. F37120-0125	12 x 5mm (1/2 x 3/16")
2. F37120-0010	10 x 6mm (3/8 x 1/4")
3. F37120-0015	15 x 6mm (5/8 x 1/4")
4. F37120-0020	20 x 8mm (3/4 x 5/16")
5. F37120-0025	25 x 8mm (1 x 5/16")
6. F37120-0030	30 x 8mm (1 3/16 x 5/16")
7. F37120-0040	40 x 8mm (1 5/8 x 5/16")
8. F37120-0050	50 x 8mm (2 x 5/16")
9. F37120-0060	60 x 7mm (2 5/16 x 1/4")
10. F37120-0070	70 x 10mm (2 3/4 x 3/8")
11. F37120-0080	80 x 10mm (3 1/8 x 3/8")

CATALOG NO.	DIMENSIONS (L X DIAM.)
ENGLISH UNITS, NO PIVOT RING	
12. F37120-7836	7/8 x 3/16" (22.2 x 4.7mm)
13. F37120-0012	1/2 x 5/16" (12.7 x 8mm)
14. F37120-0058	5/8 x 5/16" (15.9 x 8mm)
15. F37120-0078	7/8 x 3/8" (22 x 9.5mm)
16. F37120-0038	1 x 3/8" (25.4 x 9.5mm)
17. F37120-0112	1 1/2 x 3/8" (38.1 x 9.5mm)
18. F37120-0002	2 x 3/8" (50.8 x 9.5mm)
19. F37120-0212	2 1/2 x 1/2" (63.5 x 12.7mm)
20. F37120-0003	3 x 1/2" (76.2 x 12.7mm)

CATALOG NO.	DIMENSIONS (L X DIAM.)
POLYGON WITH PIVOT RING	
21. F37122-0070	2 3/4 x 3/8" (70 x 10mm)
22. F37122-0060	2 3/8 x 3/8" (60 x 10mm)
23. F37122-0050	2 x 5/16" (50 x 8mm)
24. F37122-0045	1 3/4 x 5/16" (45 x 8mm)
25. F37122-0040	1 9/16 x 5/16" (40 x 8mm)
26. F37122-0035	1 3/8 x 1/4" (35 x 6mm)
27. F37122-0025	1 x 1/4" (25 x 6mm)
28. F37122-0020	3/4 x 1/4" (20 x 6mm)
29. F37122-0012	7/16 x 3/16" (12 x 4.5mm)

Spinbar® Giant Polygon - No Pivot Ring

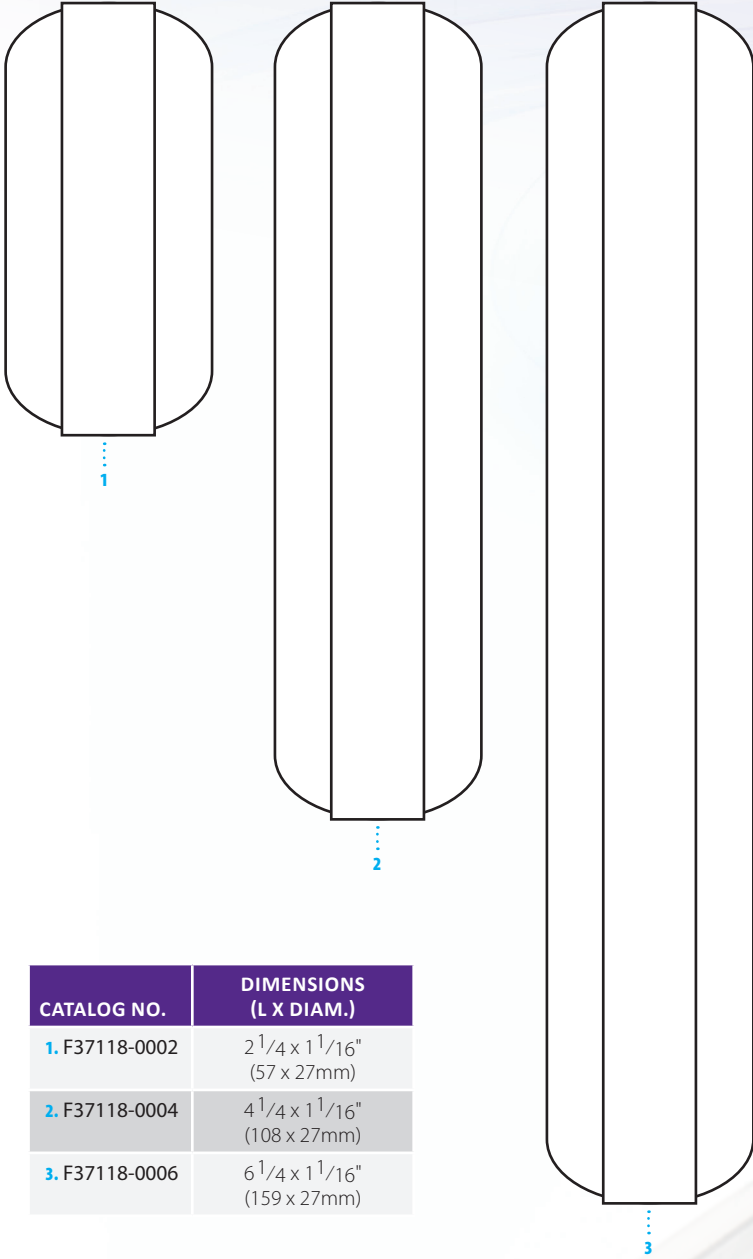

CATALOG NO.	DIMENSIONS (L X DIAM.)
1. F37118-0002	2 ¹ / ₄ x 1 ¹ / ₁₆ " (57 x 27mm)
2. F37118-0004	4 ¹ / ₄ x 1 ¹ / ₁₆ " (108 x 27mm)
3. F37118-0006	6 ¹ / ₄ x 1 ¹ / ₁₆ " (159 x 27mm)

Spinbar® Giant Polygon with Pivot Ring

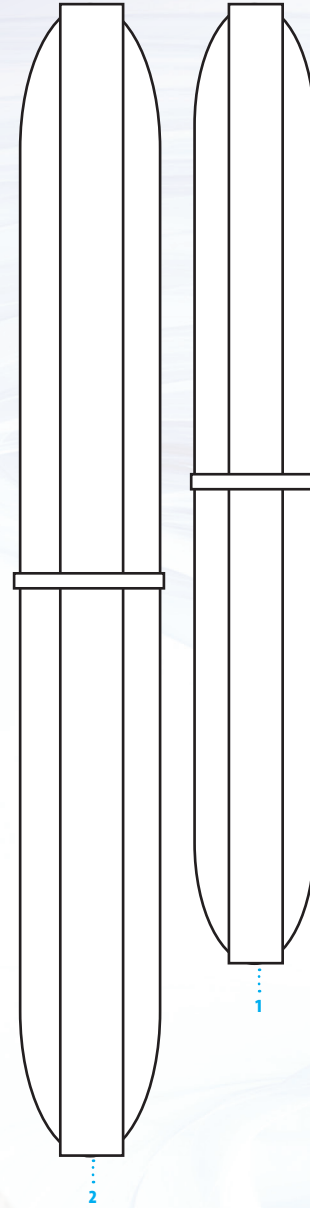

CATALOG NO.	DIMENSIONS (L X DIAM.)
1. F37122-0005	5 x 5/8" (127 x 16 mm)
2. F37122-0006	6 x 3/4" (152 x 19 mm)

Spinbar® Round Pyrex® Glass Bars

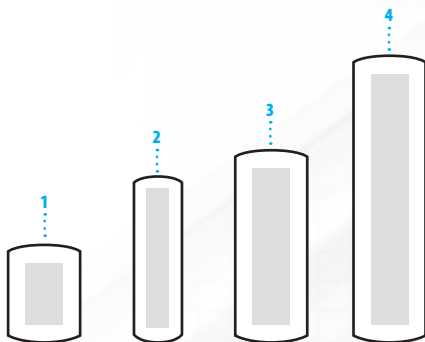

CATALOG NO.	DIMENSIONS (L X DIAM.)
1. F37101-0012	1/2 x 3/8" (12.7 x 9.5mm)
2. F37101-7814	7/8 x 1/4" (22 x 6.4mm)
3. F37101-0001	1 x 3/8" (25.4 x 9.5mm)
4. F37101-0112	1 ¹ / ₂ x 3/8" (38 x 9.5mm)

Spinbar® Saturn

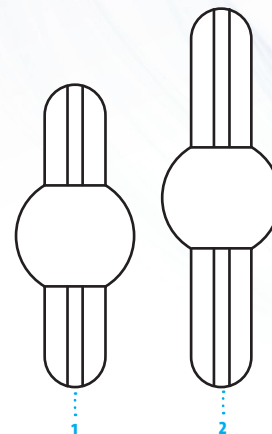

CATALOG NO.	LENGTH
1. F37116-0002	1 ¹ / ₂ " (40mm)
2. F37116-0003	2" (50mm)



Note: Actual size is correct when document printed at 100%; may render differently on computer screens

Spinvane® Bars

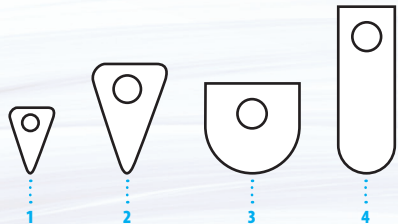

CATALOG NO.	DIMENSIONS (L X W X H)
1. F37134-0000	5.6 x 9.6 x 4.8mm
2. F37135-0000	10.4 x 16.5 x 9.8mm
3. F37136-0000	13.7 x 12.5 x 12.6mm
4. F37137-0000	9.7/6.1 x 23.0 x 9.9mm

Spinwedge® Bars

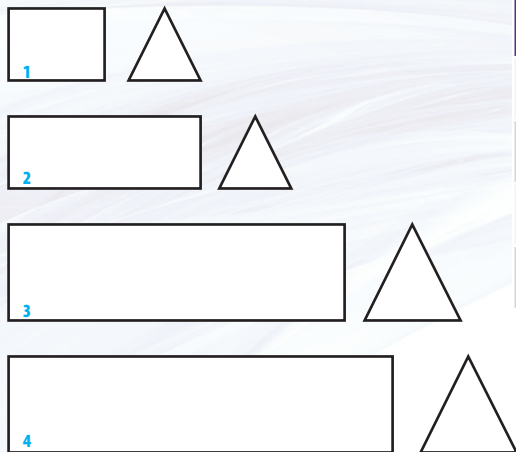

CATALOG NO.	DIMENSIONS (W X L)
1. F37123-0001	3/8 x 1/2" (9.5 x 12.7mm)
2. F37123-0002	3/8 x 1" (9.5 x 25.4mm)
3. F37123-0000	1/2 x 1 3/4" (12.7 x 44mm)
4. F37123-0003	1/2 x 2" (12.7 x 50.8mm)

Circulus™ Bars

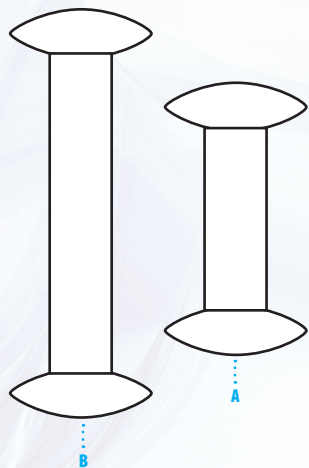

CATALOG NO.	LENGTH	DISK COLOR
A. 36MM LONG		
F37170-0000	1 7/16" (36mm)	White
F37170-0001	1 7/16" (36mm)	Red
F37170-0002	1 7/16" (36mm)	Yellow
F37170-0003	1 7/16" (36mm)	Blue
B. 54MM LONG		
F37172-0000	2 1/8" (54mm)	White
F37172-0001	2 1/8" (54mm)	Red
F37172-0002	2 1/8" (54mm)	Yellow
F37172-0003	2 1/8" (54mm)	Blue

Spinplus™ Bars

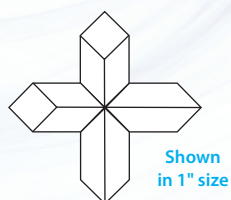

CATALOG NO.	DIMENSIONS (L X H)
F37144-0038	3/8 x 3/16" (9.5 x 4.7mm)
F37144-0034	3/4 x 3/8" (19.1 x 9.5mm)
F37144-0100	1 x 9/16" (25.4 x 14.3mm)
F37144-0114	1 1/4 x 9/16" (31.8 x 14.3mm)
F37144-0112	1 1/2 x 5/8" (38.1 x 15.8mm)

Spinbar® Micro (Flea) Bars



CATALOG NO.	DIMENSIONS (L X DIAM.)
1. F37119-0002	0.079 x 0.079" (2 x 2mm)
2. F37119-0003	0.118 x 0.118" (3 x 3mm)
3. F37119-0005	0.197 x 0.079" (5 x 2mm)
4. F37119-0007*	0.276 x 0.079" (7 x 2mm)
5. F37119-0008*	0.315 x 0.059" (8 x 1.5mm)
6. F37119-0010	0.394 x 0.118" (10 x 3mm)
7. F37119-0015	0.591 x 0.059" (15 x 1.5mm)
8. F37119-0083	0.315 x 0.118" (8 x 3mm)
9. F37119-0127	0.500 x 0.118" (12.7 x 3mm)
10. F37119-0635	0.250 x 0.118" (6.4 x 3mm)
11. F37119-1083†	0.315 x 0.118" (8 x 3mm)

*Square Ends
†With Pivot Ring

Micro (Flea) Bars – Colors Cross Reference

WHITE BAR	RED EQUIVALENT	YELLOW EQUIVALENT	BLUE EQUIVALENT
F37119-0002	F37121-0007	F37121-0008	F37121-0009
F37119-0003	F37121-0016	F37121-0017	F37121-0018
F37119-0005	F37121-0010	F37121-0011	F37121-0012
F37119-0007	F37121-0013	F37121-0014	F37121-0015
F37119-0008	F37121-0001	F37121-0002	F37121-0003
F37119-0010	F37121-0022	F37121-0023	F37121-0024
F37119-0015	F37121-0004	F37121-0005	F37121-0006
F37119-0083	N/A	N/A	N/A
F37119-0127	F37121-0025	F37121-0026	F37121-0027
F37119-0635	F37121-0019	F37121-0020	F37121-0021
F37119-1083	N/A	N/A	N/A

Note: Actual size is correct when document printed at 100%; may render differently on computer screens

Spinbar® Elliptical (Egg Shaped) Bars

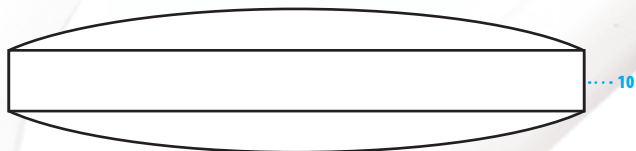
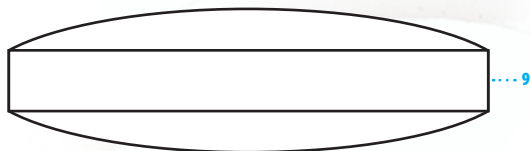
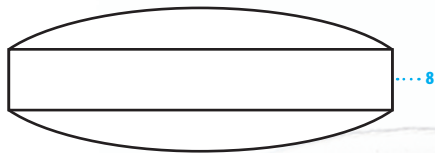
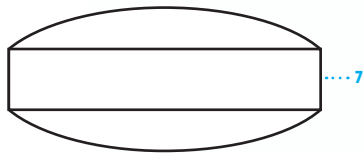
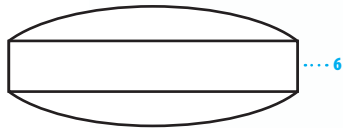
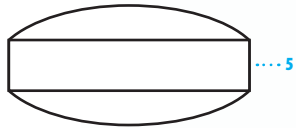
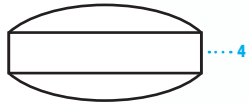

CATALOG NO.	DIMENSIONS (L X DIAM.)
1. F37130-0038	3/8 x 3/16" (9.5 x 4.7mm)
2. F37130-0058	5/8 x 1/4" (15.9 x 6.35mm)
3. F37130-0034	3/4 x 3/8" (19.1 x 9.5mm)
4. F37130-0001	1 x 1/2" (25.4 x 12.7mm)
5. F37130-0114	1 1/4 x 5/8" (31.8 x 15.9mm)
6. F37130-0112	1 1/2 x 5/8" (38.1 x 15.9mm)
7. F37130-0158	1 5/8 x 3/4" (41.3 x 19mm)
8. F37130-0002	2 x 3/4" (50.8 x 19.1mm)
9. F37130-0212	2 1/2 x 3/4" (63.5 x 19mm)
10. F37130-0003	3 x 3/4" (76 x 19.1mm)

Spinstar® Bars

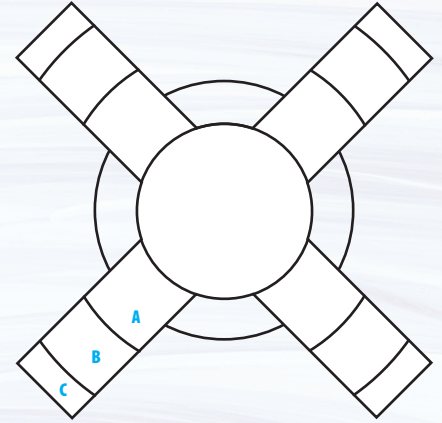

CATALOG NO.	DIAMETER
A. F37146-0100	1 3/4" (44mm)
B. F37146-0250	2 7/16" (62mm)
C. F37146-0400	2 3/4" (70mm)

Spinring® Bars

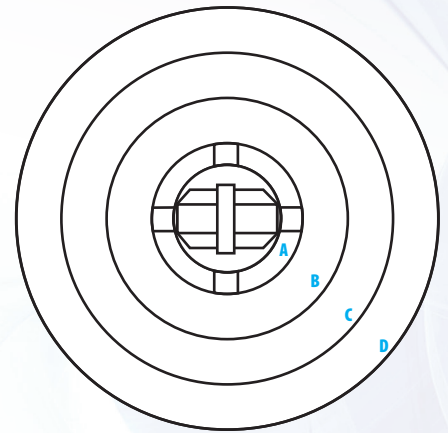

CATALOG NO.	BAR SIZE	RING O.D.
A. F37140-0005	1/2 x 5/16" (12.7 x 8mm)	3/4" (19mm)
B. F37140-0010	1 x 5/16" (25.4 x 8mm)	1 1/4" (31.8mm)
C. F37140-0015	1 1/2 x 5/16" (38.1 x 8mm)	1 3/4" (44.5mm)
D. F37140-0020	2 x 5/16" (50.8 x 8mm)	2 1/4" (57.2mm)

Note: Actual size is correct when document printed at 100%; may render differently on computer screens

Note: Actual size is correct when document printed at 100%;
may render differently on computer screens

Spinfin® Bars

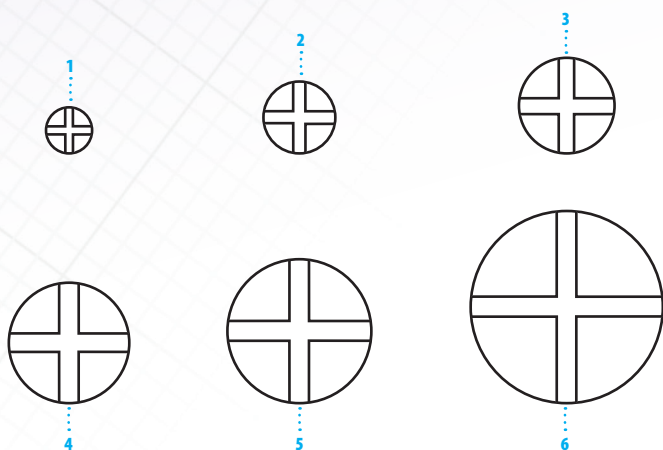

CATALOG NO.	DIMENSIONS (DIAM. X H)
1. F37125-0014	5/16 x 3/8" (7.9 x 9.5mm)
2. F37125-0038	3/8 x 3/8" (9.5 x 9.5mm)
3. F37125-0012	1/2 x 1/2" (12.7 x 12.7mm)
4. F37125-0058	5/8 x 1/2" (15.9 x 12.7mm)
5. F37125-0034	3/4 x 1/2" (19.1 x 12.7mm)
6. F37125-0078	7/8 x 1/2" (22.2 x 12.7mm)

Double Spinfin® Bars

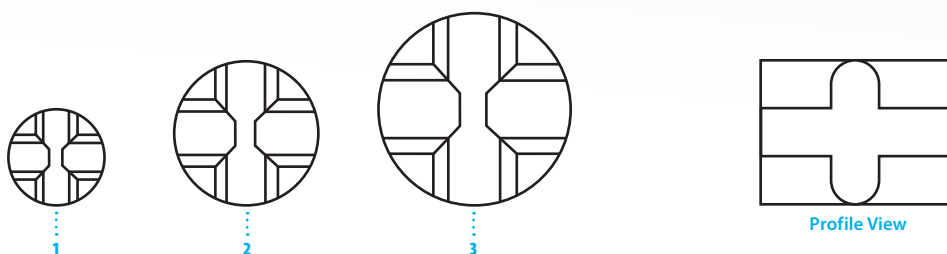

CATALOG NO.	DIMENSIONS (DIAM. X H)
1. F37126-0012	1/2 x 1/2" (12.7 x 12.7mm)
2. F37126-0034	3/4 x 5/8" (19.1 x 15.9mm)
3. F37126-0001	1 x 3/4" (25.4 x 19.1mm)

Spinbar® Capsule

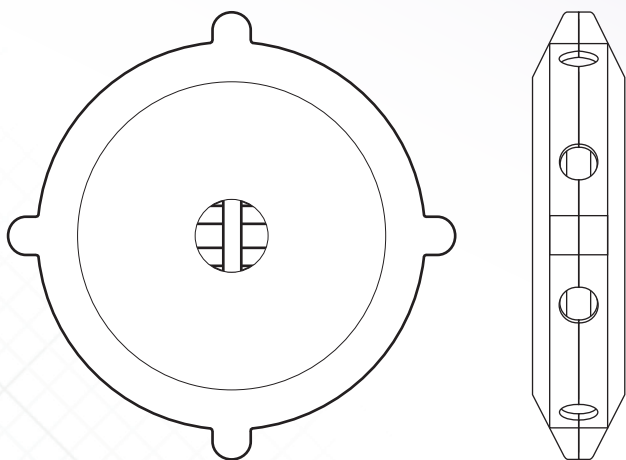

CATALOG NO.	DIMENSIONS (DIAM. X H)
F37152-0000	2.1 x 0.5" (5.3 x 1.3cm)

Plain Spinbar® Metric Units

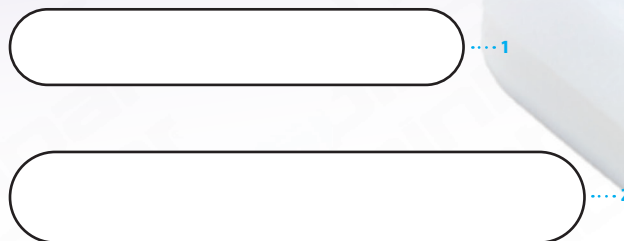

CATALOG NO.	DIMENSIONS (DIAM. X H)
1. F37120-1060	60 x 10mm (2 ³ / ₈ x 3/8")
2. F37120-1276	76 x 12mm (2 x 1/2")